

Patio Plus



ETL LISTED
CONFORMS TO
ANSI STD Z83.19

Intertek
5003356

CERTIFIED TO
CSA STD 2.35
CGA/CSA STD 2.17

infrared patio heaters Installation, Operating & Maintenance Instructions

This manual must be left with the purchaser/user of this appliance, and must remain with the appliance.

This appliance is tested and approved for use in winds up to 15 mph. (25 km/hr.) Do not use if wind is exceeding 15 mph. (25 km/hr.) or damage will result.



WARNING: Improper installation, adjustment, alteration, service or maintenance can cause property damage, injury or death. Read the installation, operating and maintenance instructions thoroughly before installing or servicing this equipment.



AVERTISSEMENT. Une installation, un réglage, une modification, une réparation ou un entretien incorrect peut entraîner des dommages matériels, des blessures ou la mort. Lisez attentivement les instructions d'installation, de fonctionnement et d'entretien avant de procéder à l'installation ou à l'entretien de cet équipement.

This manual applies to the following Patio Plus models:

- PH-45-30 P LP for use with 20 lb. **or** 30 lb. L.P. propane cylinder
- PH-45-FS-LP Liquid Propane & PH-50-FS-N Natural Gas Free Standing Units
- PH-45-FB-LP Liquid Propane & PH-50-FB-N Natural Gas Fixed Base Units
- PH-45-FB-D-LP Liquid Propane & PH-50-FB-D-N Natural Gas Fixed Base Units with direct light electronic ignition, no standing pilot, requires external 24V power supply.
- PH-45-H-LP Liquid Propane & PH-50-H-N Natural Gas Hanging Units
- PH-45-H-D-LP Liquid Propane & PH-50-H-D-N Natural Gas Hanging Units with direct light electronic ignition, no standing pilot, requires external 24V power.
- PH-45-IG-LP Liquid Propane & PH-50-IG-N Natural Gas Inground Units
- PH-45-IG-D-LP Liquid Propane & PH-50-IG-D-N Natural Gas Inground Units with direct light electronic ignition, no standing pilot, requires external 24V power supply.

The installation of Patio Plus heaters must only be performed by licensed technicians trained and educated in the installation of this type of gas appliance.

WARNING: Read this manual completely before first installing or servicing this equipment. Failure to read and fully understand this manual may result in an improper installation, which could cause faulty operation of the heater, property damage, serious injury or death. If you do not fully understand these instructions, contact your Patio Plus representative or the manufacturer prior to the commencement of installation, servicing or maintenance. Easy Radiant Works accepts no responsibility for damages whatsoever resulting in improper installation of this heater. Improper installation voids all warranties. This manual must remain with the heater at all times.

For Your Safety

Do not store or use gasoline or other flammable vapours and liquids in the vicinity of this or any other appliance.

Warning

Improper installation, adjustment, alteration, service or maintenance can cause injury, property damage or death. Read the complete installation manual and all warning labels on the appliance before installation or servicing this equipment. This heater should be installed or serviced by a qualified, licensed gas technician.

For Your Safety

If you smell gas:

1. Shut off gas to appliance.
2. Extinguish any open flame.
3. If odour continues, immediately call your gas supplier.

Consigné de Sécurité

Il est interdit d'utiliser des liquides inflammables ou dégagant des vapeurs inflammables, à proximité de tout appareil fonctionnant au gaz.

Si vous sentez une odeur de gaz:

1. Fermer le gaz sur l'appareil.
2. Éteindre toute flamme ouverte.
3. Si l'odeur persiste, contacter votre distributeur de gaz.

In all cases, the installation of this appliance must conform with all national, state/provincial, local and applicable codes for the installation of gas fired appliances. Only persons familiar with such codes and certified for the installation of gas appliances are authorized to install Patio Plus heaters. Improper installation, maintenance or adjustment of Patio Plus heaters can cause serious injury, property damage or death.

Clearances & Safe Mounting Practices.

Each heater must be installed so that the following “minimum clearances to combustibles” are maintained. Combustible materials are considered to be wood, compressed paper, plant fibers, or other materials capable of being ignited and burned. Such materials shall be considered combustible even though flame proofed, fire retardant treated or plastered. Additional clearances may be required for glass, painted surfaces, plastics, vinyl and other materials which may be damaged or melted by radiant or convection heat. A minimum clearance of 24 inches (above the heater) must be maintained to plastics, vinyl or any other materials that may be adversely affected by radiant or convection heat.

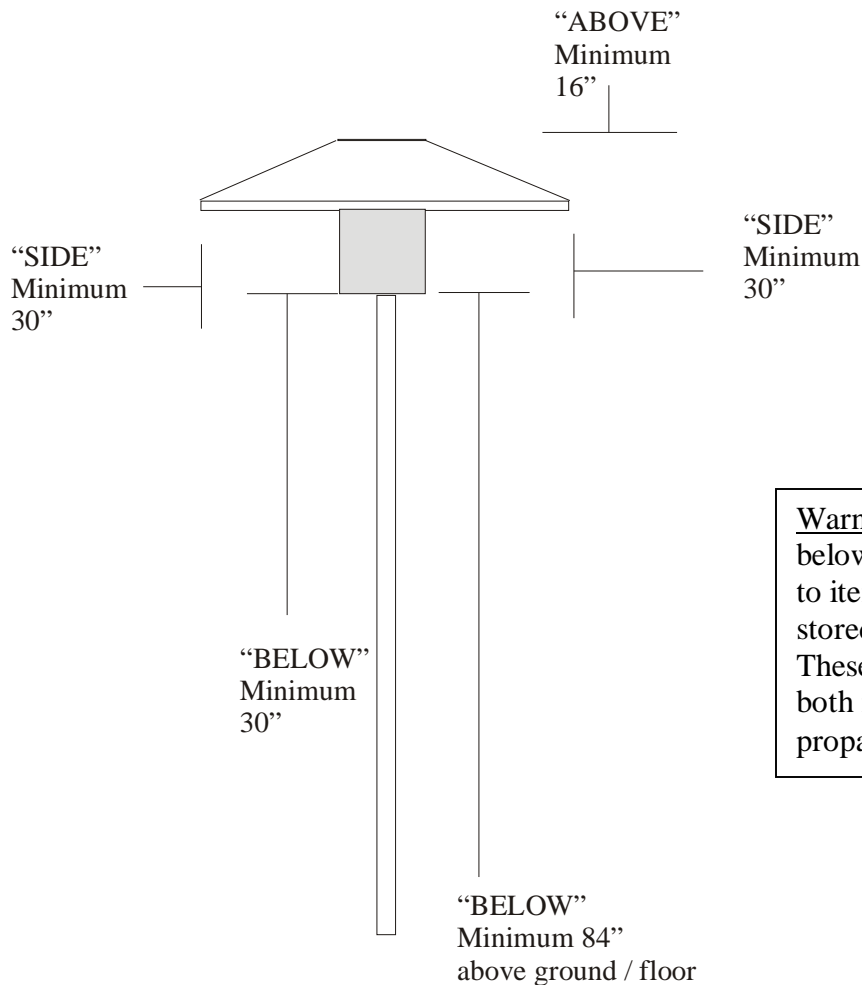

Warning: The clearances below are also applicable to items that may be stored below heaters. These clearances apply to both natural gas and propane heaters.

Infrared Heat

Patio Plus heaters are effective in heating outdoor spaces because they utilize infrared or radiant heat. Infrared energy is the same type of warmth we get from the sun. Infrared energy warms people and objects without heating the intervening air. Unlike the sun, Patio Plus heaters do not produce Ultraviolet (UV) rays that can be harmful. Infrared energy travels by line-of-sight so the designer must be aware that doors, panels or windows may obstruct the infrared energy from reaching the desired location. Overlapping infrared patterns from numerous heaters may be used effectively to provide even heat distribution. Where multiple heaters are used with the remote switching option it is suggested that they be switched independently, so as to allow for flexibility in heating larger areas as the space becomes occupied by more people. A timer is a good method to ensure that all heaters are turned off when the patio is not being used. Because infrared heaters heat people and objects, and thermostats measure air temperature, a thermostat may not be the best method for controlling outdoor heaters.

Enclosed Patios

Enclosed patios must be large enough to meet the clearance to combustibles, and ventilation requirements as provided for in all applicable codes. For very small enclosed patios, Patio Plus heaters may not be suitable. **DANGER:** Patio Plus heaters are not vented to the outdoors and therefore are subject to all local and applicable codes for unvented appliances. This heater could make Carbon Monoxide (CO). Exposure to CO can cause serious injury, brain damage or death. Failure to comply with applicable ventilation requirements could cause serious injury or death.

Patio Design Considerations

Heater placement is critical for effective and efficient patio heating. If heaters are placed too close together, or mounted too low, patrons of the patio may become uncomfortable. If heaters are placed too far apart, or too high, on a breezy or wind-swept patio, the area may never become comfortable. Infrared heaters work best if placed in areas of greatest heat loss, such as the open side of a semi-protected patio.

Windy conditions can be a problem when heating any patio. Windbreaks can be extremely effective in increasing comfort levels. The heating requirements of any patio depend greatly on local climatic conditions. It is recommended that you work with a local, and experienced supplier and installer who are familiar with the heating requirements of your area.

Important Safety Rules

1. Children and adults should be alert to high surface temperatures of areas above the post when operating this heater.
2. Children should be carefully supervised when they are in the area of the heater.
3. **NEVER** hang anything including clothes or other flammable items on the heater.
4. **DO NOT** operate this heater unless it is fully assembled with a reflector in place, and on a flat, level stable surface.
5. Installation and repairs must be done by a qualified service person. A qualified gas person should inspect the heater before use and at least annually. More frequent cleaning may be required as necessary. It is imperative that control compartments, burners and circulating air passages of the heater be kept clean.
6. **WARNING:** gas leaks are extremely dangerous and potentially explosive! Do not use this product until a leak is repaired.

Easy Testing Procedure

1. Prepare a cup of soapy water.
2. Attach regulator to your L.P. tank or gas line securely. Leave the L.P. tank outside the cabinet for the testing procedure.
3. Open the valve of the L.P. tank or turn main gas valve to heater "ON", then leave the heater valve in the "OFF" position. With a brush or sponge, apply the soap and water mixtures liberally to all connections and fittings. Any leaks will blow soap bubbles. Repair any and all leaks by tightening or replacing defective fittings. Once any and all leaks have been stopped, the heater is ready for use.

DO NOT USE A FLAME FOR LEAK TESTING

This product must be assembled and tested as shown in these instructions. Any deviation or lack of testing could cause personal or property damage. Have a qualified professional do it for you.

"Patio Plus" infra red heaters are available for both L.P. and Natural Gas and are approved for indoor & outdoor applications. This appliance must only be used with the fuel for which it was originally labeled. Do not convert this heater to an alternate fuel without first consulting the manufacturer.

For indoor use, consult all local applicable codes for unvented appliances before use.

Minimum Inlet supply gas pressure: L.P. 11" w.c. N.G. 7" w.c.

Maximum Inlet supply gas pressure: ½ P.S.I. (14" w.c.)

Required manifold pressure: L.P. 10.5" w.c. N.G. 3.5" w.c.

Maximum Input 50,000BTU L.P. & 50,000BTU Natural Gas

Maximum turn down pressure: 6.4" L.P. & 1.5" Natural Gas

Choosing a Safe Location

Heaters must be installed on a secure and level surface.

Patio Plus heaters may be installed on a combustible surface. If the heater is installed near a combustible wall or under a combustible ceiling, the minimum clearances to combustibles described in the drawing on page 2 must be adhered to. The installation must adhere to all local and applicable codes. In the absence of local codes, it must adhere to current CAN/B149 in Canada or ANSI Z223.1 in the United States

WARNING (Care & Use of L.P. cylinders)

**L.P. GAS CANNOT BE USED ON UNITS DESIGNED FOR NATURAL GAS.
NATURAL GAS CANNOT BE USED ON UNITS DESIGNED FOR L.P.**

If your heater is designed for use with an L.P. cylinder, the cylinder must meet the following requirements: cylinder weight is 20 lb. (9.07 kg); cylinder has outside diameter of 12-1/8 in. (30.8 cm), length of 18 in. (45.7 cm) and is constructed and marked to specifications of the U.S. Department of Transportation (D.O.T.) or Canadian Transport Commission (C.T.C.). Cylinder has shut-off valve outlet which is a No. 510, female P.O.L.; a safety relief device which has direct communication with vapour space of cylinder. Supply system is arranged for vapour withdrawal. Cylinder includes collar to protect valve.

If your heater is to be used on L.P. gas, special precautions should be observed when handling L.P. cylinders. Remember that this is gas and under pressure, which must be handled with care. Ask your L.P. gas dealer to show you the necessary safety precautions and check local codes for use, storage, and transport regulations. Among the recommended practices are:

1. Always keep L.P. cylinders upright.
2. Do not subject L.P. cylinder to excessive heat.
3. Avoid damage to tank valves-handle them with care.
4. Never store L.P. cylinder indoors or in direct sunlight.
5. Do not handle L.P. cylinders roughly.

Follow instructions for connecting and disconnecting L.P. cylinders for the heater and be sure to check all connections each time the cylinder is connected.

Always turn off the gas supply to the heater at the cylinder as soon as you are finished using the heater. The L.P. cylinder must be equipped with the pressure regulator and hose assembly supplied with the heater. The pressure regulator is set at the factory for maximum efficiency.

Visually inspect the entire length of the hose for damage before use. This requires opening the door of the L.P. cylinder enclosure. If damage or excess wear is found, replace the regulator assembly immediately. If needed, order only factory original parts. Do not attempt to substitute parts. Follow the steps in your assembly instructions book for removing and reinstalling the regulator assembly.

Always store L.P. cylinders in a well-ventilated space. If you intend to store the heater indoors, disconnect the L.P. cylinder and store it outside. Disconnected cylinders must have a threaded valve plug tightly installed. When the L.P. cylinder is not disconnected from the heater, the heater and cylinder must be stored outdoors in a well-ventilated space, out of reach of children.

If you have not purchased an Auto-Stop Fill Tank, never allow your cylinder to be filled above the liquid level stop fill gauge. The P.O.L. service valve and liquid level gauge are designed to be closed leak-tight by hand. If wrenches are necessary to stop a leak, the valve probably needs repair or replacement.

Check all cylinder and line connections periodically to be sure they are tight. Make certain your cylinder is properly fastened in place with the safety strap.

ASSEMBLY INSTRUCTIONS (Portable Models)

PH-45-30-P-LP (Liquid Propane) (for use with 20 lb. & 30 lb. propane cylinders).

Step 1

Carefully remove all packages from the main packing box. Remove the base assembly from the interior packing box. Gently lift the tank cover off of the base assembly and set aside. For shipping purposes, the heater head is bolted in place, inverted, inside the assembly. Gently rotate the heater head “counterclockwise” until it is free. Discard the metal threaded “T” that is holding the head in place. (See Figure 1)

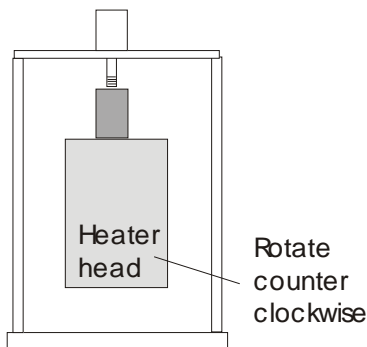

Figure 1

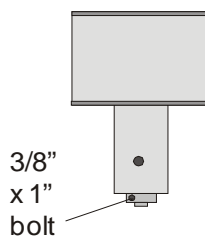

Figure 2

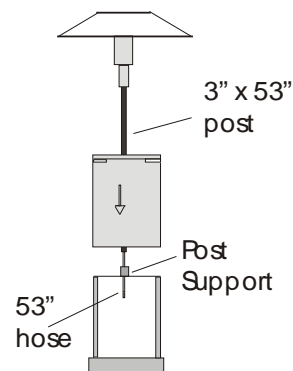

Figure 3

Step 2

Remove the 53” hose from it’s packaging and thread the ½” end into the heater head. A suitably approved pipe thread sealant must be used. Use 2 pipe wrenches to ensure a tight and leak free fit. Remove the 3/8” x 1” bolt from the base of the heater head (Figure 2) and set aside so as not to lose it. Slide the heater head / hose assembly into the 3” post. The top of the post can be identified by the 3/8” hole being at the top end. Line up the 3/8” hole in the post with the 3/8” hole in the base of the heater head, and replace the previously removed 3/8” x 1” bolt. Tighten securely.

Step 3

Replace the tank cover so that it sits down in place on the weighted base. Figure 3 Thread flexible hose down through the opening of the post support assembly and stand the post in the assembly. Raise decorative cover to allow access to the tank storage area.

Step 4

Secure the regulator to the end of the flexible hose. Use a pipe wrench and suitably approved gas pipe sealant to ensure a tight and leak free connection. Secure coupling nut on regulator into the tank outlet valve on the propane cylinder (cylinder not included).

Step 5

Secure the reflector dish to top of the heater head assembly using nuts provided

Step 6

Ensure that the heater is used on a secure and level surface, maintaining the clearances to combustibles as outlined on page 2 of this manual.

ASSEMBLY INSTRUCTIONS Model PH-45-FS-LP & Model PH-50-FS-N
Freestanding model for use with approved flexible supply line.

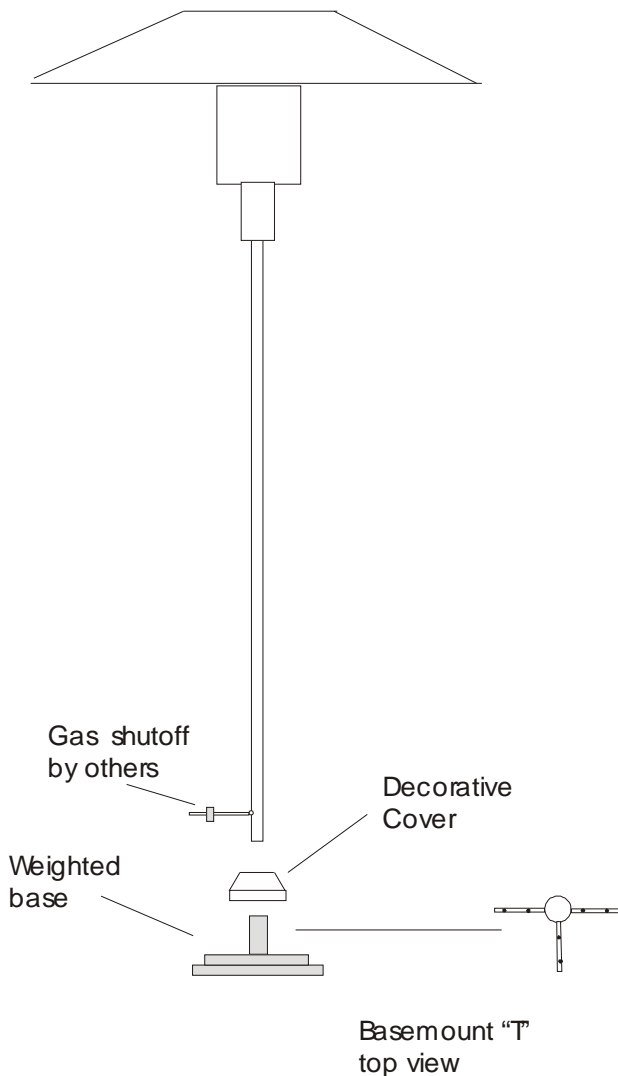

Step 1

Determine a safe, level and suitable location for the weighted base.

Step 2

Remove the 3/8" x 1" bolt in the base of the heater head and set aside. (Figure 2 previous page 7). Secure heater head to flexible hose protruding from the top of the post. Use two pipe wrenches to securely tighten. A suitably approved gas pipe sealant must be used for all gas connections. Slide head assembly into post. Align the 3/8" hole in the post with the 3/8" threaded hole in the base of the heater head, and replace the 3/8" x 1" bolt. Secure tightly.

Step 3

Slide the decorative cover onto the post from the bottom. Place the post into the basemount "T" on the weighted base and slide the decorative cover down over the post retainer. Connect gas supply to nipple protruding from the lower end of the tube. A suitably approved flexible gas line must be used for connection to the gas supply. Flex gas line is not included. Consult the local authorities for information on the types of flexible lines and quick connection couplers that are available in your area.

Step 4

Secure the reflector to the heater head with the hardware provided. Gas supply and electrical supply are to be according to all local and applicable codes. Only those individuals licensed and qualified in the installation of gas fired heating appliances are to install this appliance.

ASSEMBLY INSTRUCTIONS FIXED BASE MODELS

**PH-45-FB-LP (Liquid Propane), PH-50-FB-N (Natural Gas),
PH-45-FB-D-LP (Liquid Propane), PH-50-FB-D-NG (Natural Gas)**

Fixed base model for permanent mounting to deck or patio “D” indicates heater with direct light electronic ignition, no standing pilot. Requires switched 24 Volt power supply to heater.)

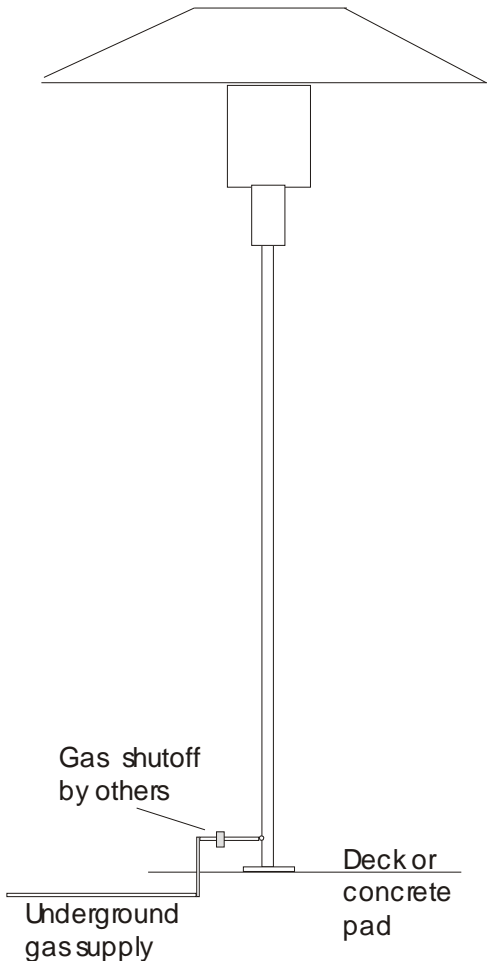

Step 1

Determine a safe, level and stable location for the base mount to be installed.

Step 2

Secure the base to the deck or concrete pad with appropriate fasteners. Use all three mounting holes. Use corrosion resistant hardware. Inspect condition of mounting studs before use of the heater each season. Replace if rusty, loose, or shows signs of damage. Use of through bolts is recommended on wood decks.

Step 3

Remove the 3/8" x 1" bolt in the base of the heater head and set aside. (Figure 2 previous page 7). Secure heater head to flexible hose protruding from the top of the post. Use two pipe wrenches to securely tighten. A suitably approved gas pipe sealant must be used for all gas connections. Slide head assembly into post. Align the 3/8" hole in the post with the 3/8" threaded hole in the base of the heater head, and replace the 3/8" x 1" bolt. Secure tightly.

Step 4

Slide the decorative cover onto the post from the bottom. Place the post into the basemount "T" and slide the decorative cover down over the post retainer. Connect gas supply to the nipple protruding from the lower side of the tube.

Step 5

Secure the reflector to the heater head with the hardware provided.

CAUTION: Gas supply and electrical supply are to be according to all local and applicable codes. Only those individuals licensed and qualified in the installation of gas fired heating appliances are to install this appliance.

D-Direct Light: If your heater has been supplied with a direct light electronic ignition, connect your switched 24 V power supply to the spade connectors protruding from the bottom end of the post. Connect spade connectors at the top of the post to the marked connections on the heater head. All supply wiring must be done in accordance with national, local and applicable codes. Only those qualified and experienced in such wiring should be engaged for the installation of the electrical supply.

ASSEMBLY INSTRUCTIONS INGROUND POST MODELS

PH-45-IG-LP (Liquid Propane), PH-50-IG-N (Natural Gas)

PH-45-IG-D-LP (Liquid Propane), PH-50-IG-D-N (Natural Gas)

for permanent inground post mounting. "D" indicates heater with direct light electronic ignition, no standing pilot. (Requires switched 24 Volt power supply to heater.)

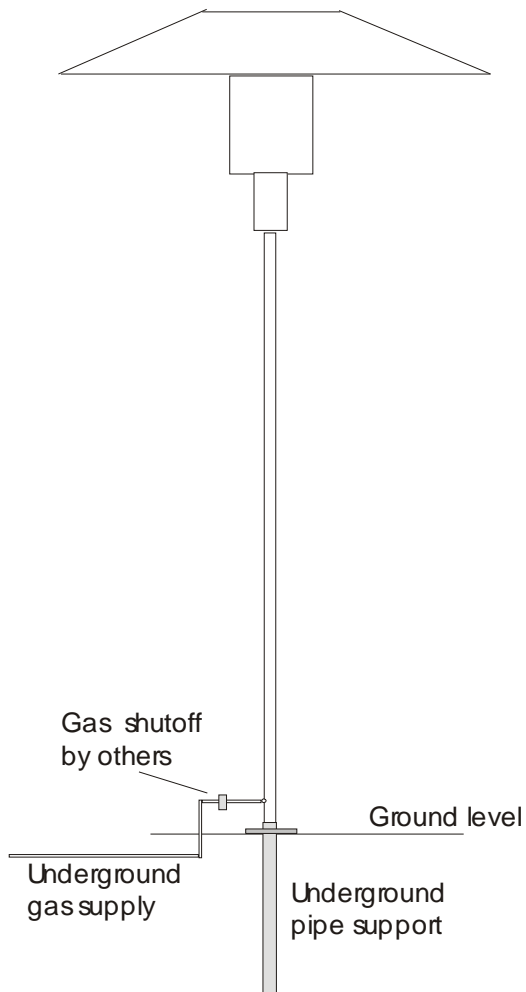

Step 1

Determine a safe, level and stable location for the heater to be installed.

Step 2

Bury ground support pipe in ground so that approximately 6" is protruding above ground level. Ensure that support pipe is plum and securely supported in concrete.

Step 3

Remove the 3/8" x 1" bolt in the base of the heater head and set aside. (Figure 2 previous page 7). Secure heater head to flexible hose protruding from the top of the post. Use two pipe wrenches to securely tighten. A suitably approved gas pipe sealant must be used for all gas connections. Slide head assembly into post. Align the 3/8" hole in the post with the 3/8" threaded hole in the base of the heater head, and replace the 3/8" x 1" bolt. Secure tightly.

Step 4

Insert post into the ground support pipe and fasten with hardware provided. Connect the gas supply to the nipple protruding from the lower side of the tube. The gas supply piping and electrical supply (if applicable) must be done in accordance with all local and applicable codes. Only those licensed and qualified in the installation of gas-fired appliances should be engaged to install this appliance.

Step 5

Secure the reflector to the heater head with the hardware provided.

D-Direct Lite: If your heater has been supplied with a 24 Volt remote switching option, or direct light electronic ignition, connect your switched 24 V power supply to the spade connectors protruding from the bottom end of the post. Connect spade connectors at the top of the post to the marked connections on the heater head. All supply wiring must be done in accordance with national, local and applicable codes. Only those qualified and experienced in such wiring should be engaged for the installation of the electrical supply.

ASSEMBLY INSTRUCTIONS

**PH-45-H-LP (Liquid Propane), PH-50-H-N (Natural Gas),
PH-45-H-D-LP (Liquid Propane), PH-50-H-D-N (Natural Gas).**

“D” indicates heater with direct light electronic ignition, no standing pilot. Requires switched 24 Volt power supply to heater.)

Hanging Model - complete with hanging bracket for suspending below an existing supporting structure.

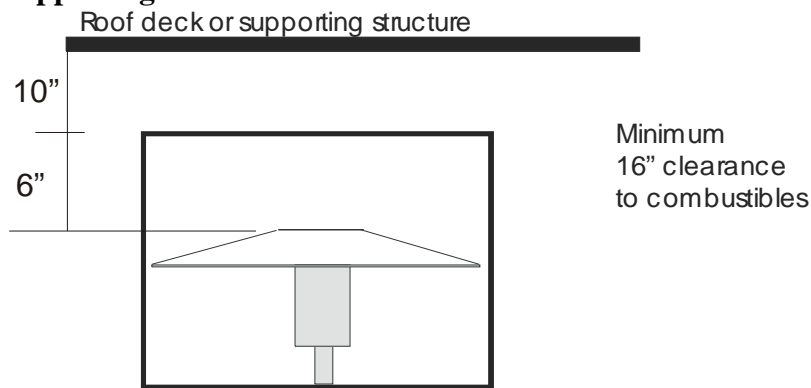
**Step 1**

Determine a safe and appropriate location for the heater to be installed bearing in mind the required clearances to combustibles and all local and applicable codes. Refer to the section in this manual “Choosing a safe location”. Clearances

to combustibles above the heater, must be increased if the ceiling is made of plastic, vinyl or other materials that may stretch or sag from convection heat. See “clearances and safe mounting practices” on page 2.

Step 2

Suspend the hanging bracket from the underside of the permanent structure bearing in mind the manufacturer’s specified clearances to combustibles. Ensure that suitable and appropriate hardware is used to suspend the heater so that it is in a secure and fixed position. Ensure that the heater is installed so that it hangs level to the ground and that stress cannot be created on the gas supply piping.

Step 3

Apply a suitably approved pipe sealant to the nipple protruding from the bottom of the hanging bracket. Turn the heater head onto the nipple to achieve a safe and tight gas connection. Insert the bolts through the holes in the support bracket and tighten securely with the nuts supplied so that the heater head is supported squarely and securely.

Step 4

Connect the gas supply to the gas supply connection located on the hanging bracket.

Step 5

D-Direct Light: Connect the 24 Volt switched power supply to the 24 Volt terminal located on base of burner. Minimum supply voltage is 24 Volt .20 V.A. Hard wiring to the heater is not supplied by the manufacturer. It must be a high temperature type wiring to withstand temperatures produced by the heater and should be run along the outside edge of the hanging bracket to protect it from excessive heat.

All supply wiring must be done in accordance with national, local and applicable codes. Only those qualified and experienced in such wiring should be engaged for the installation of the electrical supply.

Test Firing Heater

Leak test all gas connections with soapy water. Soap bubbles indicate gas leakage. Do not use an open flame to test for leaks. Test fire the heater following the lighting instructions on the heater post.

To Light Pilot (except Direct Lite)

Push and turn the control knob to “PILOT” position. Continue to hold the knob in, and purge air from the system. When air is purged, while depressing the control knob, depress the “spark igniter” button. View the pilot flame through the observation or match lighting hole. Hold the control knob depressed for 45 seconds after lighting.

If the pilot does not light, try again. It might need two or three trials to light the pilot burner. Note: for all models allow the required time to safely purge air through pilot after connecting to new gas tank or other system.

After pilot is lit and it is mistakenly turned off, the knob will be in an immovable position. Wait 90 seconds and the thermocouple will cool and knob will be released to re-light pilot.

To Light Main Burner (except Direct Lite)

After pilot is lit, wait 30 seconds and turn the control knob to the “ON” position.

WARNING

Smoke may appear around the emitter grid during the initial firing. This will only happen on the first light up. The oils used in manufacturing are burning off.

To Turn Heater and Pilot Off (except Direct Lite)

Turn control knob to the “PILOT” position. Depress slightly and turn to the “OFF” position. Wait 5 minutes after shut down before relighting heater. For propane models, turn the propane supply off when heaters are not in use.

Direct Lite, To turn heater on:

Turn manual gas valve to “on” position. Turn the electrical supply “on”.

Direct Lite, To turn heater off:

Turn electrical supply off.

Turn manual gas valve to “off” position.

Caution: Direct Lite:

If burner fails to light, turn off electrical supply for 5 minutes. Ensure there is gas to the burner. Turn electrical supply on. Do not operate in winds exceeding 15 mph / 24 kph.

Troubleshooting

Installation, servicing and maintenance of Patio Plus heaters must only be performed by licensed technicians trained and educated in the installation and servicing of this type of gas appliance.

| Problem | Possible Causes | Solution |
|---|--|--|
| Pilot won't light (exception: Direct Lite has no pilot) | -No gas to burner -Low gas pressure -Gas supply turned off -LP cylinder turned off or empty -Blockage in gas line -Ignition is not sparking | -Refill fuel tank & purge line -Refill fuel tank & purge line -Turn gas on -Refill fuel tank & turn on -Remove line, blow out obstruction -Light pilot manually to dry out or replace igniter or piezo. |
| Pilot won't stay lit (exception: Direct Lite has no pilot) | -Defective thermopile -Defective gas valve -Dirty pilot | -Replace thermopile -Replace gas valve -Clean pilot |
| Main Burner won't light | -No 24 Volt power to unit -Low gas pressure -Blockage in orifice -Manual valve not in "on" position | -Check & replace faulty wiring or transformer -Check regulators -Remove and clean orifice -Turn valve to "on" position |

**This appliance is tested and approved for use in winds of up to 15 mph (25 km./hr.).
Do not use if wind is exceeding 15 mph (25 km./hr.) or damage will result.**

In order to protect your heater from wind and the elements, the reflector should be removed and safely stored when the heater is not being used for prolonged periods of time. Cover the exposed heater head with a heavy-duty plastic bag or suitable alternative and seal securely. The reflector should be removed from all portable units if wind exceeds 45 mph. (70 km./hr.).

Maintenance

Keep the heater area clear and free from combustible materials and flammable vapours and liquids.

Do not obstruct the flow of combustion and ventilation air.

Keep the ventilation opening of the cylinder enclosure clean and free from debris.

Visually inspect the burner flame for abnormalities.

WARNING

When storing or packaging 2 or more Patio Plus reflector dishes together, you **MUST** separate them using suitable material to prevent them from sticking together or damage will occur.

Installation, servicing an maintenance of Patio Plus heaters must only be performed by licensed technicians trained and educated in the installation, servicing and maintenance of this type of gas appliance.

Warranty

Easy Radiant Works extends a 3-YEAR warranty from the date of purchase to the original purchaser of this product against manufacturing defects in material and workmanship. If this product fails to operate because of a manufacturing defect, a defective part will be repaired or replaced at Easy Radiant Works' option, if the defective part, along with proof of purchase is sent to Easy Radiant Works. All shipping charges are your responsibility.

This warranty does not apply to defects caused by accidental damage, improper handling, installation, modification, or improper connection to gas source, and specifically excludes liability for indirect, incidental or consequential damage to property.

Claims for units, damaged during shipping, must be made at the time of receiving from the carrier.

EASY RADIANT WORKS
12288 Brawn Road
Wainfleet, Ontario, Canada L0S 1V0
Phone: 905-899-3473 Fax: 905-899-2262

E-mail: erw@vaxxine.com
Website: <http://www.easyradiantworks.com>